

# Solar Pump Inverter

## User Manual

JNP2K2L-V5

JNP3KL-V5

JNP3K7L-V5

JNP4KL-V5

JNP4KL-V5-CN-V1.2

The copyright belong to Supplier

This document involves the proprietary and confidential information about Solar Pump Inverter of Supplier It strictly prohibited to disclose the document by duplicating, photocopying, publishing online and in other forms without Supplier's permission.

Supplier reserves the right to change details in this publication without notice.

# **Preface**

## **Manual Instruction**

This manual describes the transportation, installation, operation, maintenance and troubleshooting of the following JNP inverters:

- JNP2K2L-V5
- JNP3KL-V5
- JNP3K7L-V5
- JNP4KL-V5

For the convenience of the following description, “JNP2K2L、JNP3KL、JNP3K7L and JNP4K” is short for JNPxL. “Solar Pump Inverter” is short for inverter in the following content. The inverter model shall be pointed specially, when introduce the information about each model in details.

## **Target Reader**

This manual applies to the professional engineering and technical person who is responsible for installing and operating of inverter and LCD panel.

## **Use the Manual**





Please read this manual carefully before installing and operating inverter. Please keep this manual well for operation and maintenance in future.

The manual content would be constantly updated and revised, but it unavoidably has slightly discrepancies or errors with real inverter, please kind prevail if user purchases our inverter.









## **Symbol Used**

The following safety symbols may be used in this manual, and the meanings

are shown in below.

<b>Safety Symbol</b>	<b>Meaning</b>
 <b>Danger!</b>	Means that it may lead to serious accident of injuries, if safety warning is ignored.
 <b>Warning!</b>	Means that it may lead to serious accident of injuries, equipment serious damage or main business interruption, if safety warning is ignored.
 <b>Notice!</b>	Means that it may lead to moderate accident of injuries, equipment moderate damage or part of the business interruption, if safety warning is ignored.
 <b>Note!</b>	Means that the content is additional information.

Inverter related symbols:

Symbol	Meaning
	Direct current (DC).
	Alternating current (AC).
	Protective grounding .
	Refer to relevant instructions.
	Can not discard inverter together with domestic garbage .
	Beware of dangerous high-voltage.
	Should wait for 5 minutes after inverter and PV panel are disconnected, then inverter only can be touched.
	Beware of hot surface. The inverter temperature can exceed 60°C during operation. Please don't touch the surface to avoid scald.
	CE certification marks. It means that inverter complies with the requirement of CE certification.

# CONTENT

<b>PREFACE.....</b>	<b>III</b>
MANUAL INSTRUCTION.....	III
TARGET READER.....	III
USE THE MANUAL.....	III
SYMBOL USED.....	III
<b>1 SAFETY INSTRUCTIONS.....</b>	<b>9</b>
<b>2 PRODUCTION INTRODUCTION.....</b>	<b>14</b>
2.1 SOLAR PUMP INVERTER INTRODUCTION.....	14
2.2 PRODUCT'S INTRODUCTION.....	17
2.2.1 <i>Appearance</i> .....	17
2.2.2 <i>Production Dimensions</i> .....	18
2.2.3 <i>Product Name</i> .....	19
<b>3 INVERTER UNPACKING.....</b>	<b>20</b>
3.1 UNPACKING CHECK.....	20
3.2 IDENTIFY INVERTER.....	21
<b>4 INSTALLATION PROCEDURE.....</b>	<b>23</b>
4.1 PREPARE INSTALLATION TOOLS.....	23
4.2 INSTALLATION STEPS.....	24
<b>5 INSTALLATION.....</b>	<b>25</b>
5.1 INSTALLATION SITE REQUIRED.....	25

5.2	INSTALLATION DIRECTION.....	26
5.3	INSTALLATION OF INVERTER.....	27
<b>6</b>	<b>ELECTRICAL CONNECTION.....</b>	<b>30</b>
6.1	CONNECTING TERMINALS OF INVERTER.....	30
6.2	SCHEMATIC DIAGRAM OF ELECTRICAL CONNECTION.....	31
6.3	CABLE SELECTION.....	33
6.4	AC SIDE ELECTRICAL CONNECTION.....	33
	6.4.1 <i>Single phase pump description</i> .....	34
	6.4.2 <i>Capacitor removal example</i> .....	36
	6.4.3 <i>Wire connection of the connector</i> .....	37
6.5	DC SIDE CONNECTION.....	39
6.6	WATER LEVEL SENSOR CONNECTION.....	41
	6.6.1 <i>Water level sensor interface define</i> .....	42
	6.6.2 <i>Water level sensor connection</i> .....	43
6.7	COMMUNICATION CONNECTION.....	45
	6.7.1 <i>RS485 Communication</i> .....	45
	6.7.2 <i>GPRS Communication</i> .....	48
6.8	DISASSEMBLING.....	48
	6.8.1 <i>Safety Instruction</i> .....	48
	6.8.2 <i>Mounting and dismounting of cover panel</i> .....	48
<b>7</b>	<b>COMMISSIONING.....</b>	<b>50</b>
7.1	VERIFY BEFORE COMMISSIONING.....	50
7.2	INVERTER COMMISSIONING.....	50
7.3	STOP FREQUENCY SETTING.....	53
<b>8</b>	<b>LCD PANEL OPERATING INSTRUCTIONS.....</b>	<b>55</b>

8.1 INVERTER LCD DISPLAY.....	55
8.1.1 LED Indicator Direction.....	55
8.1.2 Description of Buttons.....	56
8.1.3 LCD Display Interface Overview.....	57
8.2 INITIAL OPERATIONAL INTERFACE.....	58
8.3 SYSTEM PARAMETER QUERY AND SETTING.....	60
8.3.1 Query information item description.....	60
8.3.1.2 Basic Information.....	62
8.3.1.4 Statistic Information.....	63
8.3.4 Parameter Setting.....	73
8.4 Malfunction Description.....	76
<b>9 MALFUNCTION AND TROUBLESHOOTING.....</b>	<b>79</b>
9.1 TROUBLESHOOTING.....	79
9.2 MAINTENANCE.....	85
9.3 CONTACT CUSTOMER SERVICE.....	86
<b>10 APPENDIX A.....</b>	<b>87</b>
<b>11 APPENDIX B.....</b>	<b>89</b>
11.1 QUALITY ASSURANCE.....	89
11.2 CONTACT US .....	90



# 1 Safety Instructions

For the electrical and electronics equipment, safety relates to the whole process of installation, commissioning, operation and maintenance. Therefore, incorrect use or operation would damage the life and personal security of operating person or the third party, and inverters.

In order to reduce casualties, damage of inverter and other equipment, user or operating person should strictly abide by all the safety information tips of danger, warning and notice which are in the process of operating and maintaining.



## **Warning !**

All the installation and operation of Solar Pump Inverter must be done by professional and technical person. Professional and technical person need:

- Received special training.
- Read this manual carefully and know the operation safety matters. Any damage caused by improper installation or operation will be beyond the warranty scope.

## **Before installation**



## **Notice !**

User should check the inverter if there is any damage during transportation. Please contact supplier or transportation company immediately if some problems of inverter are found.

## **Installing**

Ensure inverter does not have electrical connection with power before installation.



### **Danger!**

The solar cell arrays should be covered with opaque materials when installing the PV arrays during the day, otherwise the solar cell arrays will generate high voltage, causing person casualties.

### **Electrical connections**



### **Danger!**

Ensure that the solar cell array should be covered by light tight materials, before electrical connecting, otherwise, the solar cell array would produce high voltage under the sun to cause casualties.



### **Warning!**

- All the operation and wiring work should be operated by professional electrical or mechanical engineer.
- Please do not switch on any breaker before all equipment is not fully connected well.



### **Warning!**

If inverter damage caused by the following circumstances will be beyond the warranty scope.

- Ensure DC max. short-circuit current being in inverter allowable range when configure PV arrays, otherwise, may cause non-recoverable damage.
- When the photovoltaic array is configured, it is necessary to ensure that the open-circuit voltage of each photovoltaic group string does not exceed the maximum DC input voltage of the inverter. The maximum DC input voltage of the JNPXL series photovoltaic water pump inverter is shown in the technical parameters of each type of inverter in the appendix.



### **Warning!**

- It would affect the inverter performance and may cause inverter damage if the installation environment is improperly.
- Don't install the inverter in inflammable, explosive place or inflammable, explosive materials storage place.
- Don't install the inverter in place where is vulnerable to lightning strike.
- Don't install the inverter in place where have heavy salt fog.
- When running the inverter, please ensure good ventilation.
- Inverter should be installed erectly, and ensure the heat sink, fans are without shelter.



### **Notice !**

- All electrical installation must comply with local and national electrical installation standards
- In order to ensure safe running, proper grounding, using appropriate conductor size and providing short circuit protection are required.
- Connection cable must select suitable specification, firm connection and good insulation.

### **Running**



### **Danger !**

- When the AC side of the inverter is running with AC load, the DC connection cannot be directly disconnected. Firstly, make sure that the inverter is shut down and there is no AC output. Make sure there is no voltage between the AC input side and the DC input side, then the AC and DC input side can be disconnected.
- Please don't plug any connector when inverter is charged with power.
- Please don't open the cover plate when inverter is charged with power.



### **Notice !**

Only LCD display screen and DC switches can be touched when the inverter is running, the heating devices (such as radiator, etc.) should not be touched to avoid scald.

## Maintenance



### **Danger!**

- Maintenance should be done by professional maintenance technical person.
- Before maintenance, make sure to disconnect the electrical connection on the input side of inverter, wait at least 5 minutes, Measure DC side and AC side voltage of inverter with voltage meter, Make sure to operate without voltage on both DC and AC sides

## 2 Production Introduction

### 2.1 Solar Pump Inverter Introduction

Solar pump system is different from traditional AC pumping system, which takes use of solar cells to convert solar energy into electricity.

It consists of 4 parts: PV modules, **Solar Pump Inverter**, AC pump and water storage device. **Solar Pump Inverter** converts DC power produced by PV module into AC power required by the pump motor. A microprocessor inside continuously monitor available energy levels and adjust pump speed, matching energy required to energy available. The JNPxL series solar pump inverters increase AC input supplement function, on basis of traditional Solar pump inverter. In the case of insufficient PV energy, the AC input energy can be supplemented according to the demand to ensure the normal water supply of users at night or cloudy days. This enables the system to operate under varying solar isolation levels, and provide water throughout the day and through different seasons. The solar Pump Inverter utilize a high efficiency MPPT algorithm to maximize power harvested from PV module.



#### **Warning!**

Inverter can't be connected with the PV array, which positive or negative is grounded!

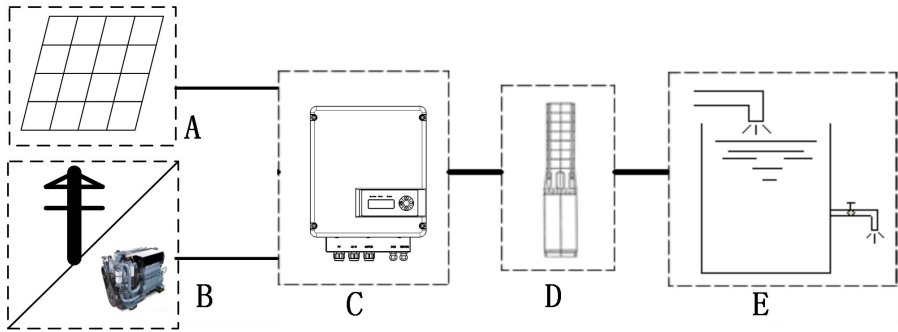

Figure2-1 Solar pumping application system

Table2-1 Solar pumping application system list

No.	Name	Description
A	PV array	Monocrystalline silicon, Polycrystalline silicon.
B	Grid/Diesel generator	Single phase AC source.(see the appendix of each model for specific requirements)
C	Solar pump inverter	JNP2K2L-V5,JNP3KL-V5,JNP3K7L-V5, JNP4KL-V5.
D	AC pump	Single phase or three phase AC pump.
E	Water storage device	Can be the reservoir, fields etc.



Note!

When the photovoltaic water pump system is configured, it is necessary to

ensure that the maximum power point voltage  $V_{MP}$  of the photovoltaic array is basically equal to or close to the AC rectifier voltage. That is,  $V_{MP} \approx 1.414 \cdot U$  line, the input voltage of JNPXL series grid is single-phase input inverter  $U$  line is single-phase AC voltage, for example, for JNPXL series single panel 30VMP, 11 in series,  $V_{MP} = 30 \cdot 11 = 330V \approx 1.414 \cdot 220 = 311.08V$ . If the configuration of the photovoltaic array is not appropriate, the photovoltaic energy utilization rate may be poor when the photovoltaic energy and AC energy are connected simultaneously.



## 2.2 Product's Introduction

### 2.2.1 Appearance

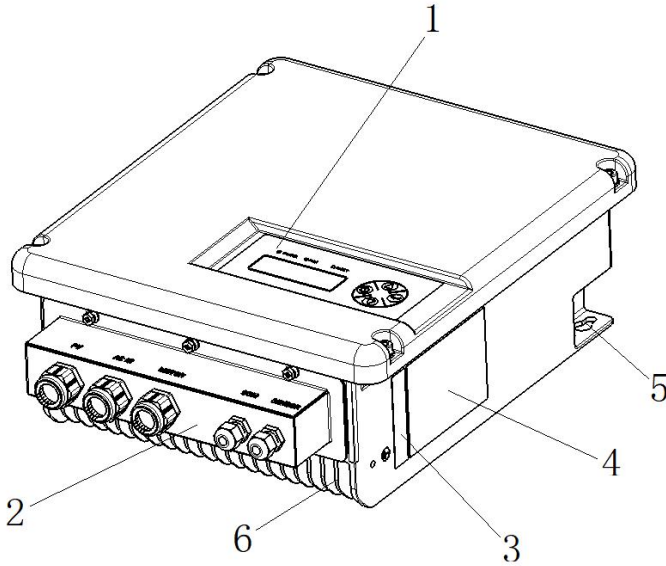

Figure2-2 Appearance of Solar Pump Inverter

Table2-2 Inverter appearance information table

No.	Name	Introductions
1	LCD display screen	Man-machine interface, you can check the inverter operating information through LCD display screen, also can set some function and parameters of inverter.
2	Terminals Cover	Including DC input terminal (PV+ 、 PV-);AC input terminal(AC IN); output terminal (MOTOR); sensor

		connection terminal (SERSOR) and communication terminal(COM) under the cover.
3	Machine serial No.	The serial number of the inverter, should be provided during after-sales service
4	Nameplate	The basic parameters of the inverter are listed on the name plate
5	Hanger	Used to hang the inverter on the bracket.
6	Radiator	Help the machine to dissipate heat. The temperature of the inverter is high during operation. DO NOT touch it!

### 2.2.2 Production Dimensions

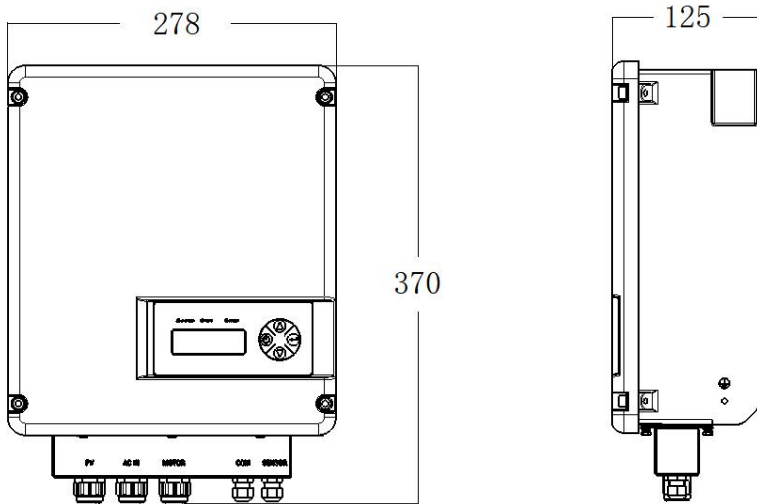

Figure2-3 Dimension drawing of Solar Pump Inverter (unit : mm)

Table2-3 Inverter dimension table

Model	Width(mm)	Height(mm)	Depth(mm)	Net weight (kg)
JNP2K2L-V5	278	370	125	6.5
JNP3KL-V5	278	370	125	6.5
JNP3K7L-V5	278	370	125	6.5
JNP4KL-V5	278	370	125	6.5

### 2.2.3 Product Name

The Naming of product, take JNP3K7H-V5 for example:

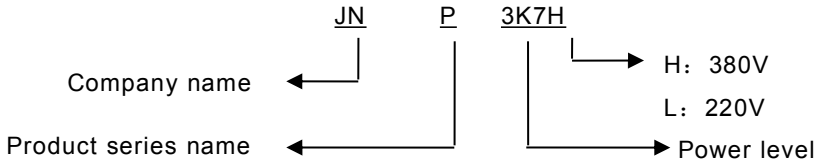

# 3 Inverter Unpacking

## 3.1 Unpacking Check

The product has been tested and checked carefully before transportation, but damage may be caused during transportation, therefore, the product should also be checked carefully before installation.

- Please check whether inverter outer packing is in good condition;
- After unpacking, please check whether the equipment is in good condition;
- According to the packing list to check whether all the parts is correct and in good condition.

If any damage is found, please contact supplier or the transportation company. Please keep well the photos taken at the damaged parts and we'll provide you with best and fastest services.

Supplier supply the standard inverter and commonly used accessories as below:

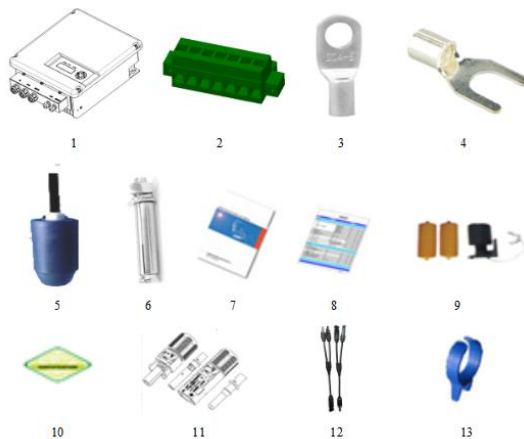

Figure3-1 Inverter and standard fittings



## Note!

Photos are for reference only, please adhere to the original product!

**Table3-1 Inverter and fittings table**

No.	Description	Status
1	Solar Pump Inverter	Standard
2	Signal terminal block	Standard
3	Cold-pressed terminal(SC4-5)	Standard
4	Cold-pressed terminal(SC6-5)	Standard
5	Expansion bolt(M6*60)	Standard
6	Water level sensor B	Optional
7	Quick Installation Guideline	Standard
8	Packing list	Standard
9	Water level sensor A	Optional
10	Certificate of inspection	Standard
11	Photovoltaic connector	Standard (JNP2K2L is optional)
12	Y connector	Standard (JNP2K2L is optional)
13	Ring tool	Standard (JNP2K2L is optional)

## 3.2 Identify Inverter

The nameplate in the side of inverter, and it shows the inverter model, main parameters and certificate mark.

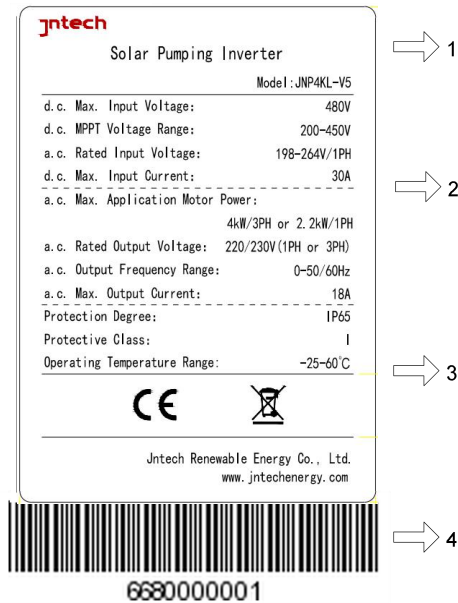

Figure3-2 Inverter nameplate

Table3-2 Nameplate information table





NO.	Description
1	Inverter name and model
2	Inverter parameter information
3	Certificate and safety signs, concrete meaning as “Preface”
4	Inverter factory number

## 4 Installation Procedure

### 4.1 Prepare Installation Tools

The following tools will be needed during inverter installation and wire connection. You also can choose the right tools according to your own experience.

Table4-1 Installation tools list

Sketch map	Name	Recommend specification	Function
	Wire crimpers	M2.5~M8	For crimping of cold terminals.
	Electric drill	Φ8	Used for inverter installation plate fixed hole drilling.
	Straight screwdriver	Φ3	For the installation of communication connecting wires.
	Cross screwdriver	Φ5	Used for disassembling inverter cover.
	Inner hexagon spanner	5#	Used for disassembly and assembly of inverter cover panel.

## 4.2 Installation Steps

Tools ready, follow these steps to install.

Table4-2 Installation process

Installation steps	Installation instruction	Reference chapters
1	Before installation, check whether the inverter is in good condition;	
	Whether the product fittings are complete	3.1
	Whether the installation tools and spare parts are complete	4.1
	Whether the installation environment meets the requirements	1
2	Read the manual, especially the "Safety Instructions"	1
3	Choose the best installation location	5.1
	Installation	5.3
4	Electrical connection	6
	Select cables	6.3
	AC side wire connection	6.4
	DC side wire connection	6.5
	Sensor wire connection	6.6
	485 communication wire connection	6.7
5	Commissioning	7
6	Configuration parameter	8
7	Faults	9



## 5 Installation

### 5.1 Installation Site Required

Inverter installation site environment has very important influence to the safe operation, the performance and life of the inverter. Choose the right installation site before install the inverter.

- All installation must comply with local standards.
- Do not install the inverter at a flammable or explosive place or a place where the flammable or explosive materials are stored.
- Do not install the inverter in a place where there is a risk of explosion.
- Do not install the inverter in places where the inverter is vulnerable to lightning strike.
- Do not install the inverter in a higher salt spray environment.
- Inverter installation site must be in good ventilation, do not install the inverter in the closed case, otherwise the inverter will not work properly.
- Inverter protection level is IP65, can be installed outdoor, when the inverter is installed outdoor, should be installed as far as possible in the eaves or other have the shadow place, avoiding direct sunlight, rain and snow.
- Inverter is installed indoor, keep away from windows, avoiding lightning
- The installation place selected should be solid enough to support the inverter weight for a long period.
- The site for inverter installation must be clean and the ambient temperature must be maintained within -25 to +60 °C.
- Inverter installation site relative humidity should not be more than 95%, water vapor may corrode inverter, and damage the internal components.
- The inverter must be installed in a place convenient for observation and

maintenance.

- Don't install the inverter in living area, the inverter will produce some noise when running, influence daily life.

## 5.2 Installation Direction

- The inverter should be installed vertically or titled backwards with a maximum angle of 10°.
- Do not install inverter tilted forwards.
- Never install the inverter horizontally.

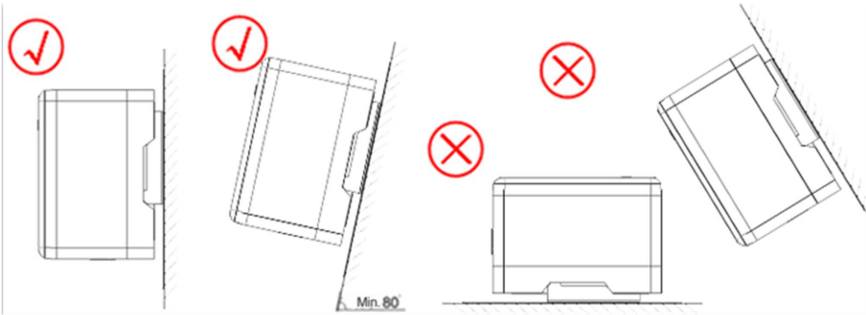

Figure5-1 Installation directions

- The installation height of inverter should be convenient for operation and reading out of the LCD displayed information.
- Do not install the inverter in a place where children can touch.
- The inverter uses air cooling mode and the installation site selected should ensure the minimum installation spacing between the inverter and the fixed object and the nearby inverters to ensure an good ventilation. And in front of the inverter need to keep enough space, is convenient to check the LCD display information.

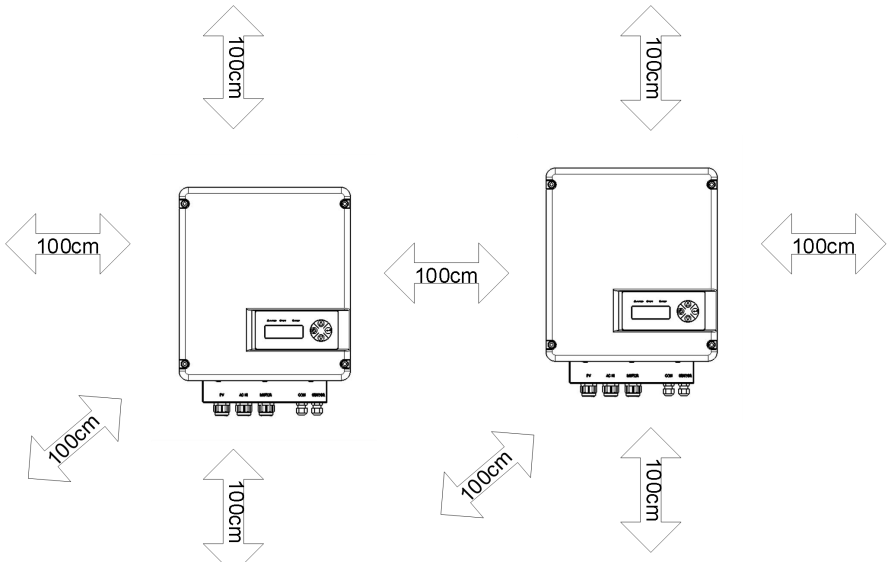

Figure5-2 Minimum spacing of adjacent installations

Table5-1 Minimum spacing dimension

Direction	Minimum spacing
Above	100cm
Below	100cm
Sides	100cm
Front	100cm

### 5.3 Installation of Inverter



Note!

Do not use jackbolts or screws to install inverters on rocks or panels.



### Note!

- Fix the inverter on the rock or panel with the toggle bolt or screw is not permitted.
- Supplier would provide the bolt which suitable for the installation on the concrete wall.
- If the inverter is fixed on the wooden wall, please choose suitable bolt to finish the installation, the bolt length should be enough and penetrate the 1/2 depth of the walls.

#### Step1:

According to the size of the inverter, select a suitable position on the wall, and it is recommended to drill  $8+1/-0$ mm in diameter,  $60+5/-0$ mm in depth and 210mm in spacing. Drive the expansion bolt into the hole.

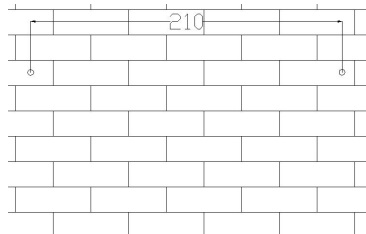

Step2:

Fasten the inverter lug through the expansion bolt and fix it in the positioned holes.

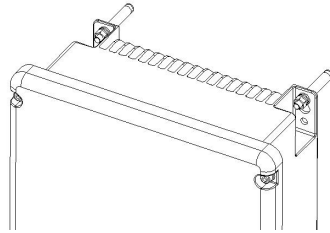

Step3:

Lock the expansion bolt until it is close to the wall.

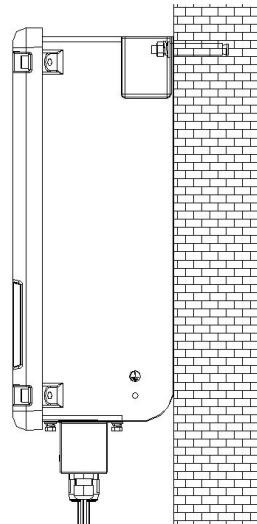

## 6 Electrical Connection

The electrical connection can be carried out when the mechanical installation of inverter is completed. The following operation specification must be followed when making electrical connection.



### **Warning!**

- All the electrical connection must meet local electrical connection standard.
- Only qualified electrical personnel can perform the wiring installation work.
- Incorrect wiring operation may cause operating casualties or equipment damage permanently.
- Ensure that there is no electricity in DC side before the electrical connection.
- Grounding correctly, using proper conductor and taking necessary Short-circuit protection to ensure the safe operation of inverter.
- Don't switch on any breaker before all the electrical connection are finished.

### **6.1 Connecting Terminals of Inverter**

All connection terminals are at the bottom of the inverter, Remove the terminal cover with a cross screwdriver, It contains DC side input (PV) terminal, AC side AC input (AC IN), AC output (MOTOR) terminal, communication terminal and water level sensor terminal inside The DC side input terminal, AC side input and output terminals, and the grounding terminal are connected by a terminal block. The communication terminal and water level sensor terminal are connected by a signal terminal block. Please refer to Figure6-1.

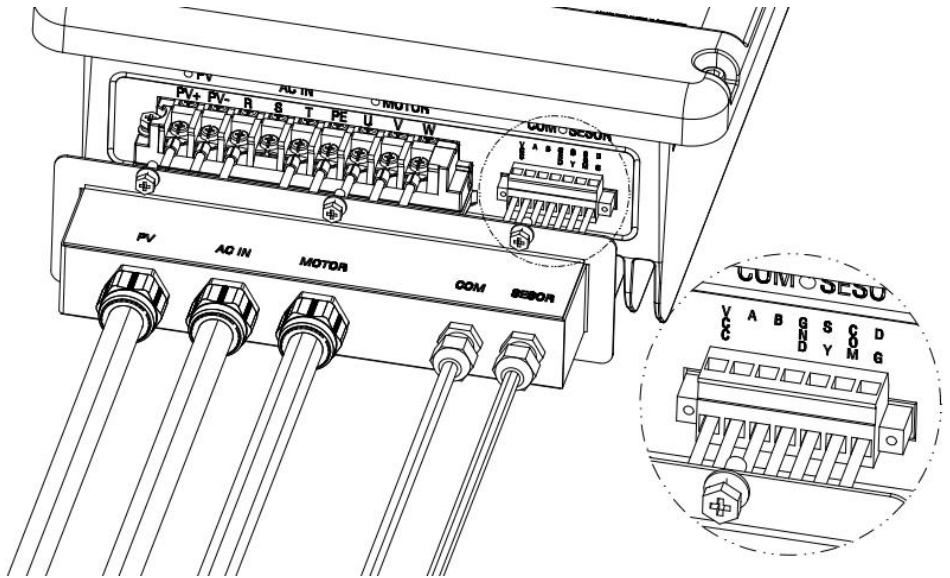



Figure6-1 External connection terminals of inverter

Table6-1 Description

Terminals	Description
AC IN	AC input terminals, including R,S,T,PE.
PV	PV array DC input terminals, including PV+,PV-.
MOTOR	Output terminal, connect with AC pump, including U,V,W.
SENSOR	Water level sensor signal input terminal (optional)
COM	RS485 or GPRS communication interface (optional)
	Grounding terminal(Grounding screw on the right side of inverter case)

## 6.2 Schematic Diagram of Electrical Connection

Figure 6-2 is the schematic diagram of electrical connection among PV arrays,

Solar Pump Inverter and three phase AC pump. Water level sensor and communication interface shall be connected if needed.

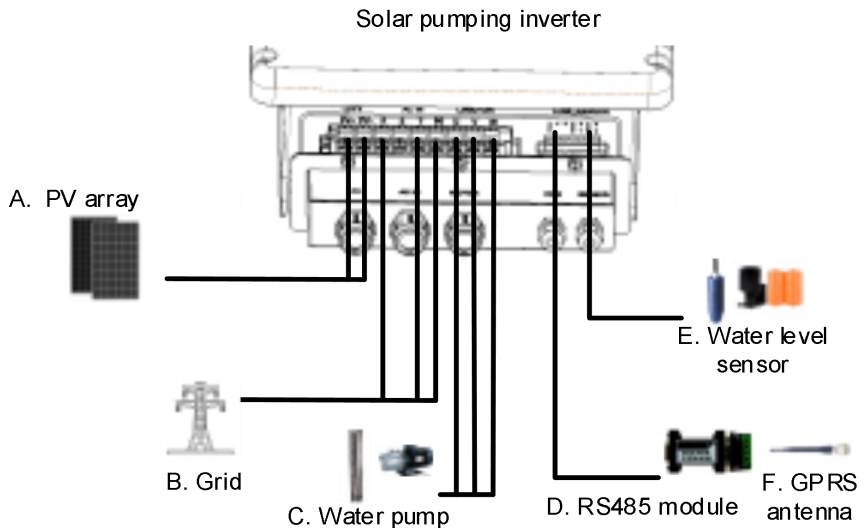

Figure6-2 Electrical connection diagram of Solar Pump Inverter

Table6-2 Equipment list of Solar pump system

No.	Equipment name	Description
A	PV array	The max. Voc of each string is 880V.
B	Grid	Power grid, diesel engine and other single AC input source.
C	Pump	Single phase or three phase AC pump.
D	RS485 Communication	Optional, can be purchased from Supplier



	module	
E	Water level sensor	Optional, for Dry or Overflow protection.
F	GPRS module	Optional, Use for GPRS communication.

### 6.3 Cable Selection

Please select cable according to the following table.

Table 6-3 Specification of Cables for Electrical Connection

Inverter	Cable range (AWG)			Cable recommended (AWG)		
	DC side	AC side		DC side	AC side	
	PV+、PV-	U、V、W	PE	PV+、PV-	U、V、W	PE
JNP2K2L-V5	14-12	14-12	12	12	12	12
JNP3KL-V5	12-10	12-10	12	10	10	12
JNP3K7L-V5	12-10	12-10	12	10	10	12
JNP4KL-V5	12-10	12-10	12	10	10	12

### 6.4 AC Side Electrical Connection



#### Notice!

It's forbidden to connect several inverters in parallel to one set of pump!



#### Danger!

Ensure that all cables have no charge before electrical operation!

### 6.4.1 Single phase pump description

Single phase pump is widely used in household and small power water delivery system with its advantages of simple structure, low cost, low noise, easy access to power, etc. Usually, single phase pump consists of a main winding (running winding), a secondary winding (starting winding), and a starting capacitor.

Note: Some single phase pump consists of two capacitors, one starting capacitor and one running capacitor. In the connection of single phase pump, this two capacitors are always connected together, after that, the connection is same as one capacitor pump. No further description here.

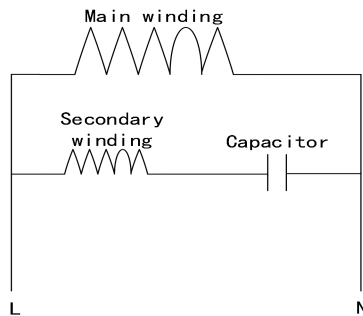

Figure 6-3 Diagram of single phase pump inner winding

While using our JNPxL-V5 series single phase solar pump inverter, the capacitor of single phase pump needs to be removed. Then draw a wire at the common end of the main and secondary windings, draw two wires at the other end of the main and secondary windings. Then connect this three wires and one ground wire to the AC connector of inverter, as shown below:

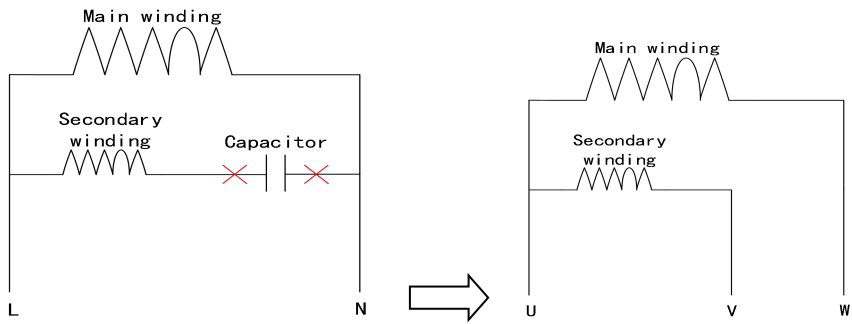
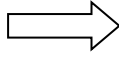
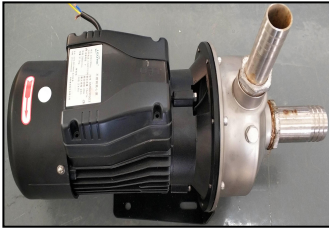

Figure 6-4 Schematic diagram of removal for single phase pump

### 6.4.2 Capacitor removal example



Step 1: Put the single pump on the open and hard ground.

Step 2: Remove 4 fixing screws from end cover plate with cross screwdriver and remove end cover plate.

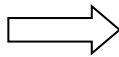

Step 3: After remove end cover, find the terminal connected to the capacitor lead, loosen the fastening nut and remove the original wire of capacitor and motor.

Step 4: Prepare a four-core motor extension wire, fix the ground wire in the “ $\perp$ ” position, connect the other three wires to the three terminals and fix them with nuts. Finally, cover it.

### 6.4.3 Wire connection of the connector

**Step1:** Connect the wires first:

Follow the steps below to connect the AC wires:

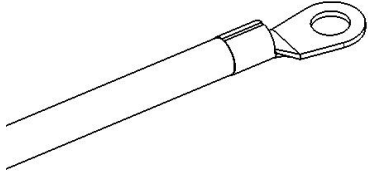
Operation Instruction	Operation Demonstration
<p>Step1. Fasten three-phase output and grounding wires to the cold pressing terminal (SC4-5) with crimping pliers separately. Fasten the power grid input conductor to the cold pressed terminal (SC6-5).</p>	

**Step2:** Fix the AC input cable through the AC IN waterproof connector to the corresponding terminal (R, T, PE), and fix the water pump power supply cable through the Motor waterproof connector to the corresponding terminal (U, V, W).

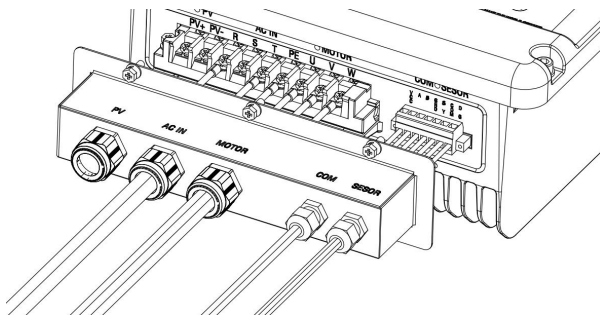

Figure6-3 AC side electrical connection

**Step3:** Connect the cables between pumping inverter and AC pump.



**Danger!**

When the input AC terminal is connected with the inverter, the circuit breaker at the AC input side shall be disconnected, otherwise the AC input will generate dangerous voltage, causing personal injury and death. Do not operate wiring by non professionals.

Please make sure the AC input and AC output wiring is correct, Do not connect the input and output reversely, otherwise the inverter will be damaged.

Please ensure that the fire wire, zero wire and ground wire of single-phase AC input are correctly connected to the corresponding terminals of R, T and PE. The terminals marked as S of the machine are vacant and not connected. Do not connect R, T and AC input to the wrong ground, otherwise it will damage the machine.



**Note!**

The phase sequence between AC pump and inverter must be same, otherwise, it shall lead to less output or without water. Whether Phase sequence is corresponding or not should be tested when the pump system trial run for the first time.

For single phase pump, there is no sequence required after start capacitors are moved out.



### **Caution!**

JN2K2L-V5, JN3KL-V5, JN3K7L-V5, JN4KL-V5, AC input is single phase 220-240V, 50/60Hz.

AC input voltage frequency is: 50Hz/60Hz.

## **6.5 DC Side Connection**



### **Danger!**

When carrying out connection between PV array and inverter, the PV array should be covered with opaque materials and the DC-SWITCH should be disconnected, otherwise, the PV array may generate dangerous voltage, cause casualty. The Non-professionals do not make the connection operation.



### **Warning!**

Before connecting PV array to the inverter, ensure the earth impedance between PV array and ground is not less than 1Mohm.



### **Note!**

- If there is more strings PV modules in parallel, each string PV module should be with the same model, the same number of PV modules, the same inclination angle, the same azimuth angle, and the same cross-sectional area of the connecting wires.
- Inspect every system carefully before installation.

**Step1:** Please connect the wire of DC according to the following steps:

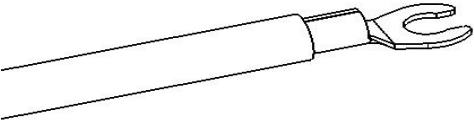
Operation Instruction	Operation Demonstration
<p>1. Fasten the DC conductor to the cold pressed terminal (SC6-5) with a press pliers.</p>	

**Step2:** Through the PV waterproof terminal on the terminal cover, fix the DC wire (PV +, PV -) on the terminal, pay attention to the positive and negative poles shouldn't be connected reversely, and ensure that the circuit breaker at the DC side of the system is in the off state.

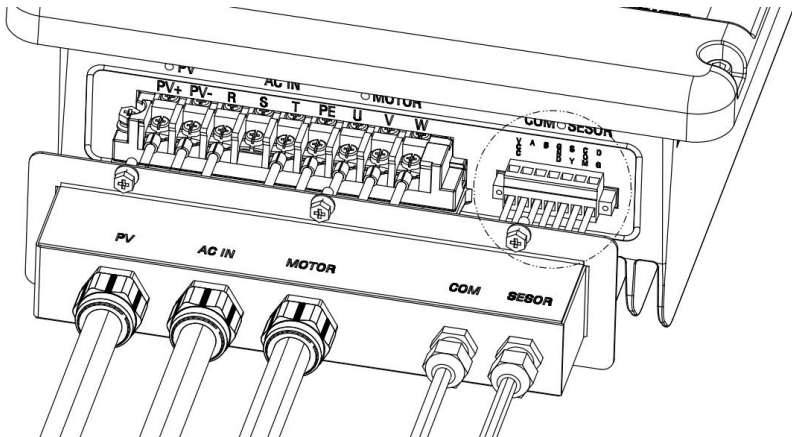

Figure6-4 PV side electrical connection





### **Warning!**

Make sure the Positive and Negative poles connection of PV array and Inverter are correct!

## **6.6 Water Level Sensor Connection**

**Dry protection function:** There are two kinds of detection models, automatic and manual. Automatic dry protection is achieved through inverter's software. And manual model need water level sensors to input signal through SENSOR inside Inverter.

**Overflow Protection:** water level sensors are requested to input signal through SENSOR inside Inverter.



### **Note!**

- The water level sensors' location is designed according to your system situation.
- Water level sensor can be bound in corresponding position on the pipeline connected to the pump. Other method also can be used to ensure the water level sensor is in the right position.
- The installation of water level sensor must be reliable and effective.
- When use water level sensor to achieve function of overflow protection, set "**OFF**" as "**ON**", please refer to "**8.3.4.3 Key Parameters of the System Set**" for detail information.

### 6.6.1 Water level sensor interface define

Water level sensor connector pins in inverter panel port are defined as below:

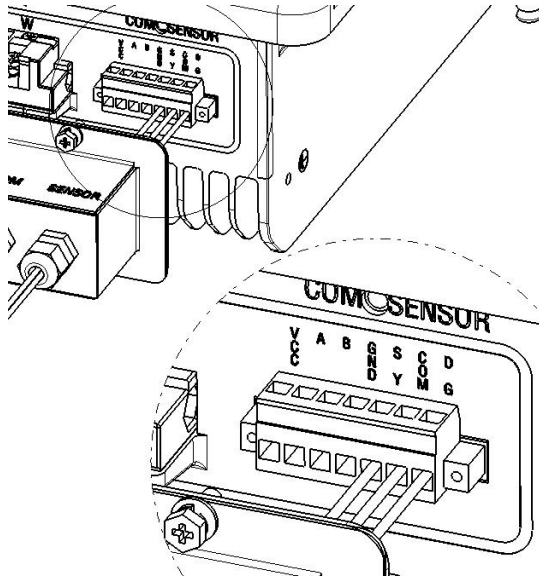

Figure6-5 Water level sensor interface define

Table 6-4

Terminal ( SENSOR ) pin	Detail
DG	Dry protection pin
SY	Overflow protection pin
COM	Dry protection and Overflow protection common pin,



### Note!

Above three input signal of water level sensors is passive signals, which is matching opening or closing signal of the corresponding water level sensors.

## 6.6.2 Water level sensor connection

Two kinds of water level sensor you can select as shown below:



Sensor A

Sensor B

Figure6-6 Water level sensor



### Notice!

If you select overflow protection water level sensor, you need to set the value of

“OF-F”, the LCD menu “Settings” → “Para Set” → “OF-F” to modify to “ON”.

The setting method with reference to “**8.3.4.3 Key Parameters of the System Set**”.

If you selected water level sensor A, then water sensor installation method is shown below:

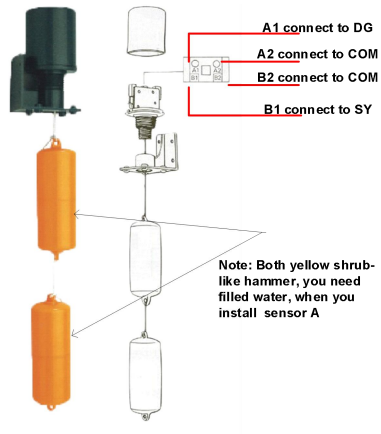

Figure6-7 The detail figure of Sensor A

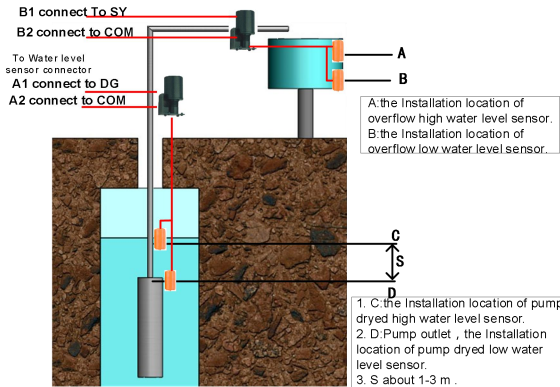

Figure6-8 The installation figure of Sensor A

If you selected water level sensor B, then water sensor installation method is shown below:

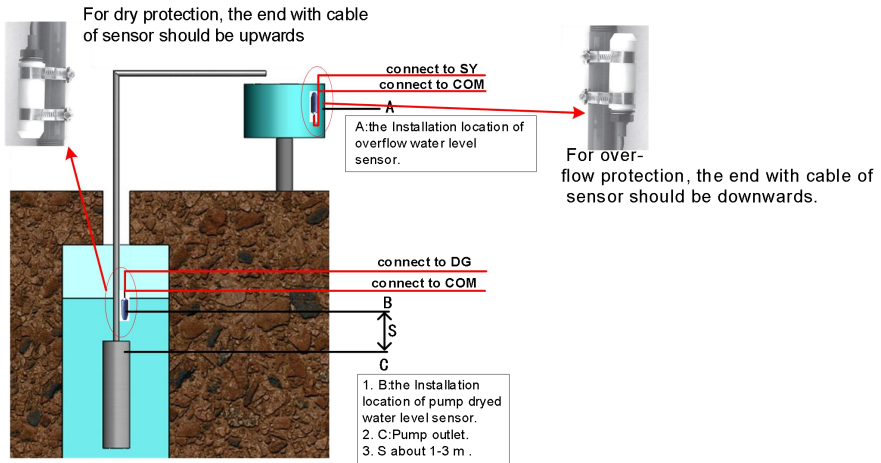

Figure6-9 The installation figure of Sensor B



## Notice !

If you choose Water Level Sensor B, please note the following aspects when intall:

1. For dry protection, the end with cable of sensor should be upwards;
2. For over-flow protection, the end with cable of sensor should be downwards.

## 6.7 Communication Connection

### 6.7.1 RS485 Communication

When the inverter communicates with a single machine, the communication between the inverter and the monitoring equipment can be connected through the communication cable. The COM outside the inverter is the remote

communication terminal, and the output terminal wire is connected to the monitoring equipment (computer).

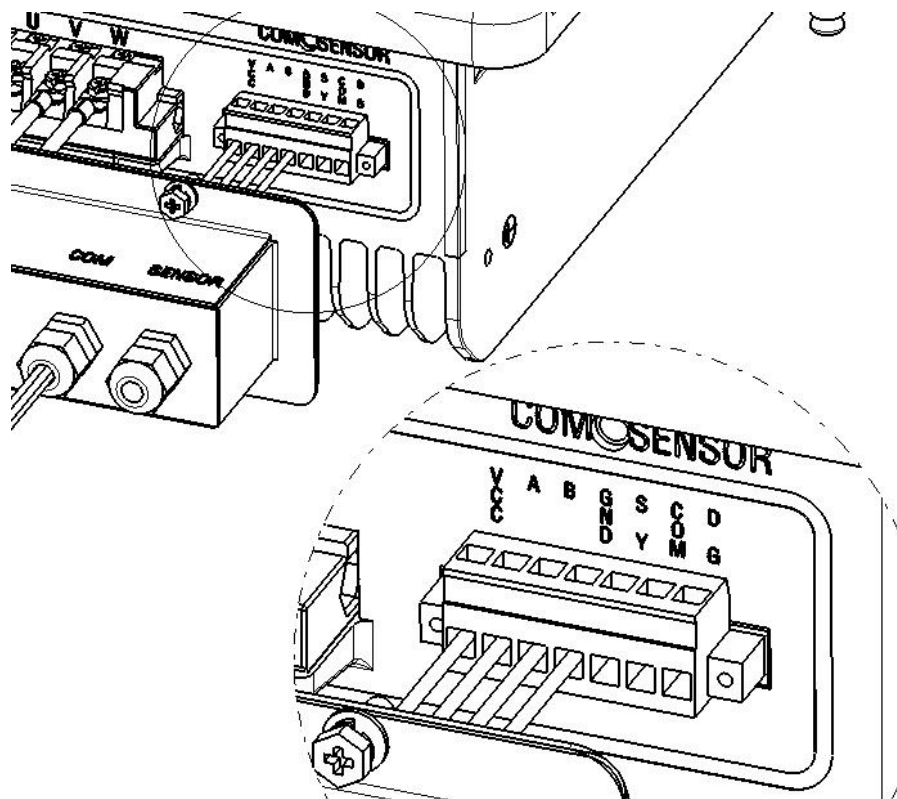

Figure6-10 Communication connection terminal

The com part of the machine panel and the water level sensor use the same terminal block, and the pin definitions are shown in the table below:

Table 6-5 COM terminal pin definition on machine panel

Terminal ( SENSOR ) pin	Detail
VCC	+5V power supply
A	RS485 communication port A.
B	RS485 communication port B.
GND	Electrical grounding

The following diagram guide you to connect a single inverter to monitoring equipment.

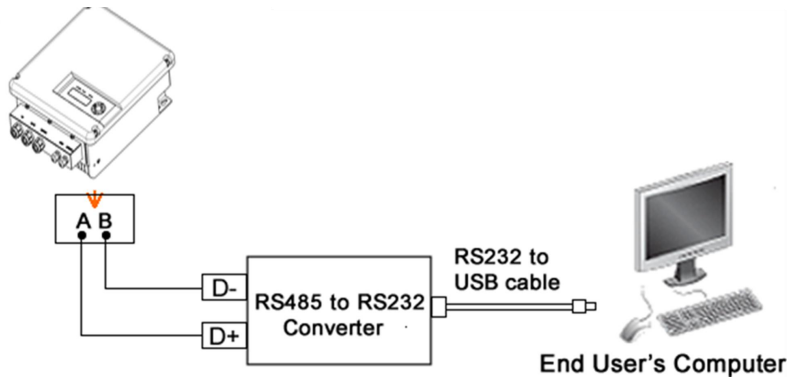

Figure6-11 Diagram of single communication wiring

The wiring diagram is schematic diagram, just take HEXIN converting module as an example. If the user choose other converter, need according to the converter's instructions, wiring the inverter's A, B wires to the converter's correct terminal.

Please refer to “**Inverter Management System User Manual**” for the corresponding monitoring software settings, after completing the wire connection.



### **Note!**

- The monitoring software is optional, when choose this function, “**Inverter Management System User Manual**” can be found from the accompanying CD.
- The inverter is supplied with default address "10".

## **6.7.2 GPRS Communication**

Note: More information about the communication module, please refer to the **User and Installation Manual For GPRS**.

## **6.8 Disassembling**

### **6.8.1 Safety Instruction**



### **Warning!**

Before disassembling the inverter:

- Disconnect AC and DC side circuit breakers.
- Waiting for a few minutes till ensure the inverter is uncharged.



### **Notice!**

Electrostatic discharging will cause damage to the inner components of inverter. We should carry out the antistatic measure before disassembling and assembling.

### **6.8.2 Mounting and dismounting of cover panel**

For maintenance reason, you may need open the cover of inverter, and ensure better



seal performance, please operate according to the following instruction.

1. When open the inverter cover, first use a cross screwdriver to remove the grounding screw on the right side of the inverter case, and then use a 5# Allen wrench to screw down the cover plate fixing screws in turn, and install the gasket under the screw. When screwing down, pay attention to prevent the gasket from falling off.
2. when cover it back, first use a cross screwdriver to lock the grounding screw on the right side of the inverter case, then screw all the cover screws into the screw holes, use a 5 × Allen wrench, with a torque of  $1.8 \pm 0.2N \cdot m$ , first lock the diagonal screws, and then lock the other screws in turn.

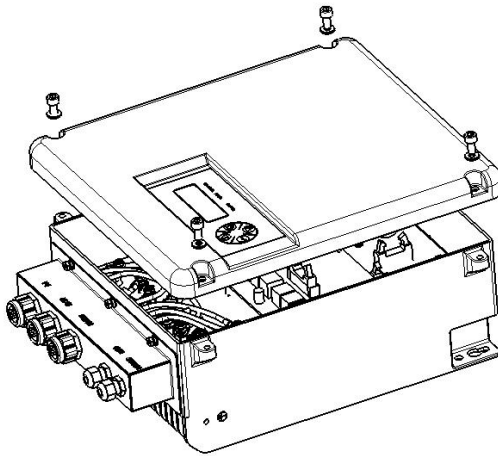

Figure6-12 Reference picture of Mounting and dismounting

# 7 Commissioning

## 7.1 Verify before Commissioning

### **PV Arrays**

The PV array should be checked before operating the inverter, and to ensure that the positive and negative mustn't be misconnect, otherwise, the damage may be caused to the inverter. Make sure that the open-circuit voltage of PV array doesn't exceed the required voltage.

### **DC Input**

Make sure that the DC terminals of the inverter are connected correctly and maintained consistent with the PV array.

### **AC Input/Output**

For single-phase AC input inverters, please ensure that R and T of AC input terminals are properly connected, and do not connect R and T to the grounding pin. Ensure that the output end of the inverter is connected correctly, check whether the AC is connected correctly, and the protection ground of the system is connected correctly.

### **Verify of the water pump motor parameters**

Check the electrical parameters on water pump motor nameplate: the rated input voltage and input current frequency, to ensure inverter is matched with the pump.

## 7.2 Inverter Commissioning

Choose suitable weather, with enough sunshine, and make sure the normal operation of your Solar pump system. Try to ensure that inverter work under high output power, high output frequency as much as possible. Please make sure the following condition before commissioning.

- Ensure that the inverter is connected correctly to the AC motor.
- Ensure that the polarity of PV arrays is correct.
- Ensure that the AC Input R、 T and GND is correct.
- Check whether the system pipeline is unobstructed or not.
- Switch on the DC-side circuit breakers.

After finishing the above steps, then begin initialization.

According to the pump motor rated current value on the nameplate, setting inverter overload protection value, the method is: modify the "Imotor" value equal to 1.2 times of the motor rated current, the details please refer to chapter **"8.3.2.3 DSP Parameter Settings"** **"8.3.4 parameters"** settings.

After finishing the above steps, machine shall start operation after long-time pressing the "ON/OFF" key for 3s; check if the Solar pump system works properly or realize suitable head of delivery and flow. Press "ON/OFF" and stop the inverter. Disconnect the DC side input of the PV array, connect the AC input side power supply, and repeat the above operations.



### **Note!**

The inverter has four working modes, which are factory default as "0" :

When the debugging mode is "0", it means that the inverter is in the economic mode. When the photovoltaic power is lower than the grid access power, the grid is connected to ensure the full load operation of the inverter. When the photovoltaic power is greater than the grid exit power point, the grid gradually exits until it completely exits.

When the debugging mode is "1", it means that the inverter is in the reliable mode. When the photovoltaic power becomes weak and cannot maintain the full power operation of the inverter, the power grid is connected to keep the inverter running at full power. When the photovoltaic power can maintain the inverter

running at full power, the grid exits.

When the debugging mode "2" is selected, it means that the inverter is in the pure photovoltaic mode, and the power grid cannot be connected, and only photovoltaic energy is used for operation.

When the debugging mode is "4", the inverter is in the motor detection mode, which needs to be modified only for single-phase pump load. After the motor parameter detection is completed, the debugging mode is automatically modified to "0".

The inverter generally defaults to three-phase output. If the pump load is single-phase pump, special parameters of the inverter shall be set as follows:

- When the output is connected to the single-phase pump and the system is powered on, the inverter "parameter setting" interface needs to be entered. The "output selection" of the inverter is modified to "1" ("0" represents the three-phase inverter output," 1 "represents the single-phase inverter output).After modification, the inverter must be switched off and powered on again. For specific modification steps, please refer to the chapters of "8.3.2.2 DSP Parameter Setting" and "8.3.4 Parameter Setting".
- After power on and restart, change "Debug mode" to "4".Please refer to the section "8.3.2.2 DSP Parameter Setting" and "8.3.4 Parameter Setting" for specific modification steps.

Long press the "ON/OFF" key ON the inverter panel for 3 seconds, the "RUN" light will always be ON after flashing, the inverter will start to RUN, and the system will work (if the load is single-phase pump running for the first time, select "Yes" after motor parameter detection, and the inverter will start to RUN).At this point, it is necessary to check whether the photovoltaic pump system is working normally and whether it can reach the head and flow of the system .After running for a period of time, press the "ON/OFF" key ON the LCD

panel of the inverter to stop the inverter and turn OFF the "RUN" light. Disconnect the DC input of the PHOTOVOLTAIC array, connect the AC input, and repeat the above operation.



**Note!**

- Output power of inverter drives the pump working; the pump will stop working while the inverter stops.
- for the first test run, if there is any abnormality, the inverter will report a fault, please refer to "**9.1 troubleshooting**" section.
- System commissioning, may be abnormal, such as no flow, or flow rate cannot reach the designed value, or even the three phase water pump issued by abnormal sound. Please kindly check below:
  - a) Three-phase AC pump reversal (saying three-phase pump connected wrong), you need to stop and set "M-Mode", please refer to the Chapter "**8.3.2.3 DSP Parameter Settings**" and "**8.3.4 Parameter Settings**";
  - b) Output power of PV module is too weak;

### 7.3 Stop Frequency Setting

Solar pump system for the first time trial run is successful, need to set the system shutdown frequency, as follows.

Step 1: Ensure the system is running and there has water output. To enter "StopFreq" interface. Please refer to "**8.3.2.3 DSP Parameter Settings**" "**8.3.4 parameters**" .

Step 2: To reduce the value of "StopFreq". Reduce 5 each time (every change need to press "ENTER" to confirm). Keep reducing till there just has no water output, and make a small change to just get small water come out, and the value is the very data of "StopFreq".

Step 3: Exit the "StopFreq" interface.

Finish the debugging.



**Note !**

The set of “StopFreq” can ensure inverter stop working when the output power of PV array is too weak to pump water, which can increase the pump’s lifespan.

# 8 LCD Panel Operating Instructions

## 8.1 Inverter LCD Display

There are three LED lights, four buttons on the LCD Display, shown in figure 8-1.

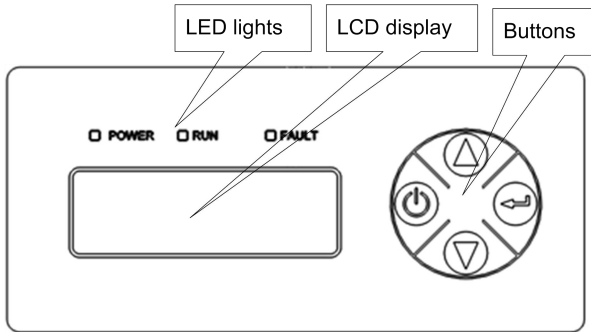

Figure8-1 LCD Display

### 8.1.1 LED Indicator Direction

Table8-1 LED Indicator Direction

LED Indicator	Name	Color	Instructions
POWER	Power light	Green	Light on When power on
RUN	Running light	Green	Light on under normal operation
FAULT	Faulty light	Red	Light on when error occur, off when fault disappear

#### Detail Explanation of Indicator





- When inverter is powered on, “POWER” indicator (green) will be lighted.
- Communication fault occurs, “FAULT” indicator flashes rapidly.
- Other outage or shutdown mode occurs, “FAULT” indicator will be lighted,

until fault or status are cleared.

- When invert is running normally, “RUN” indicator will be lighted in green.

### 8.1.2 Description of Buttons

Table8-2 Buttons Function Table

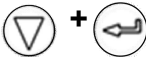
Buttons	Name	Functions
	“ON/OFF”	Press once to stop; long time press for 3s to get it started.
	“UP”	Page up and increase data. long time press for Continuous increase.
	“DOWN”	Page down and decrease data. long time press for Continuous reduction.
	“ENTER”	To choose and confirm.
	“DOWN+ENTER”	Return to main interface.



#### Note!

When inverter is powered on, LCD display background is lighted, and after 30s normal running, the background light turns off.



### 8.1.3 LCD Display Interface Overview

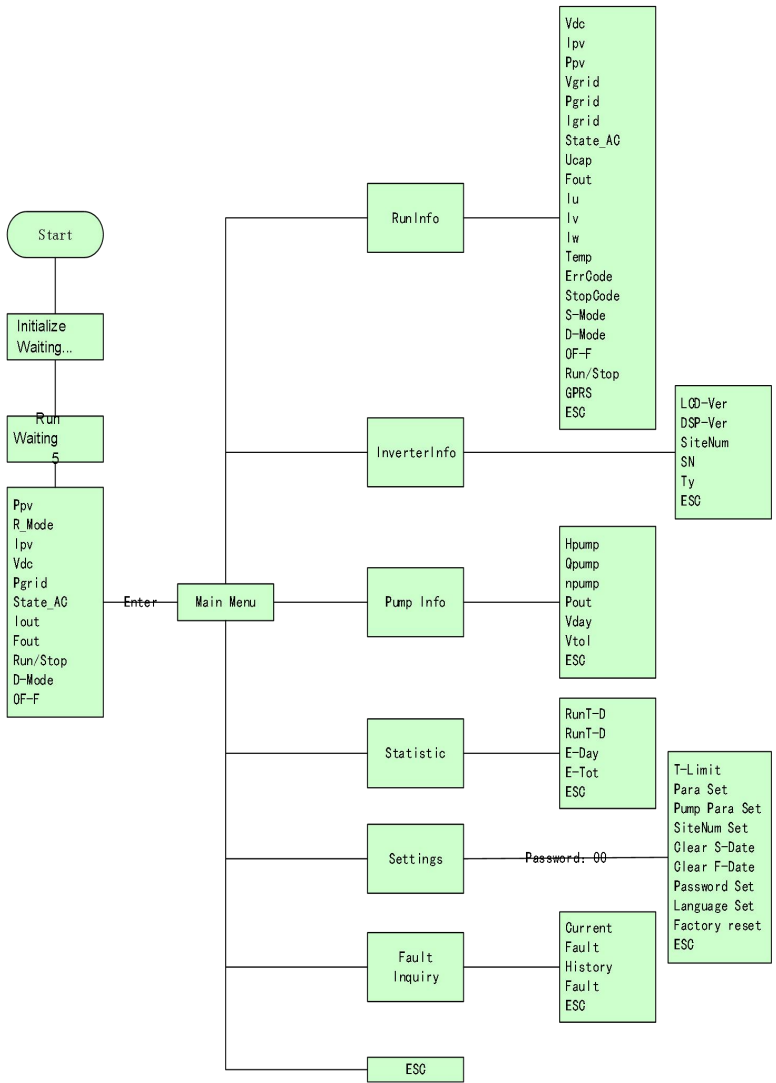

Figure8-2 LCD diagram (1)

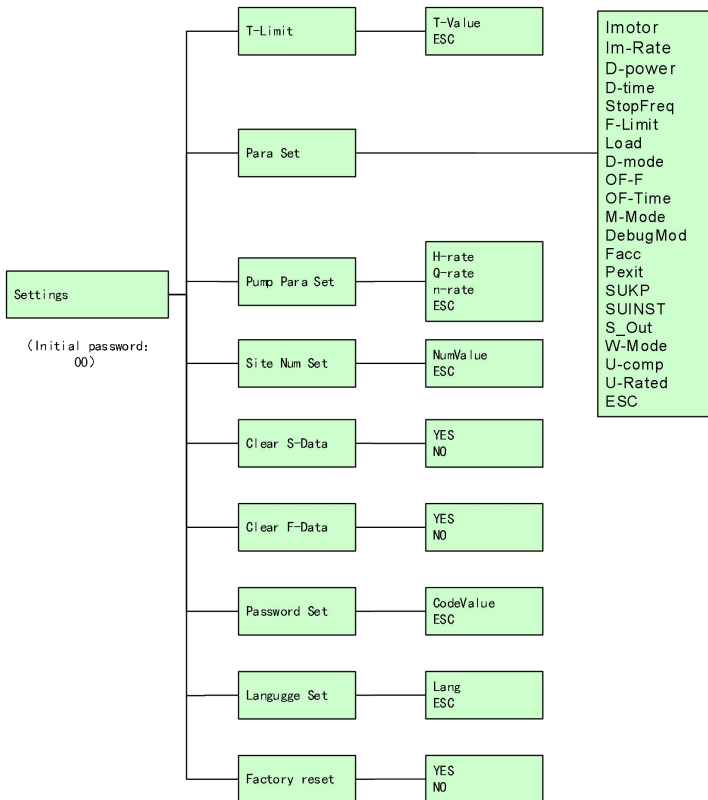

Figure8-3 LCD diagram (2)

## 8.2 Initial Operational Interface

Once the inverter power on, the system start to initialize, display the initialization interface:

Initialize  
Waiting...

#### Figure8-4 System initialize

If the start-stop mode is auto., countdown interface will be display after initialization complete, and when countdown finished, LCD will enter the main interface, inverter will drive water pump. "RUN" indicator light.

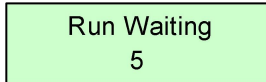

Figure8-5 Countdown interface

If the start-stop mode of the system is manual (factory default setting), long press the "ON/OFF" key for 3s, and the inverter will start up and run.



#### Note!

- The default mode of inverter is manual start-stop mode. When inverter power for the first time, it need key-press to start the inverter to drive pump.(Run after long-time press "ON/OFF"), at the same time, manual start-stop mode will change into automatic start-stop mode directly.
- Press "ON/OFF" stop the inverter and it will get started while long-time pressing "ON/OFF", if not do like this, the system won't start.
- The inverter can work at regular intervals, that is, the inverter automatically stops after the set working time. For details, please refer to "**8.3.2.1 Timing Shutdown Time Setting**" and "**8.3.4 Parameter Setting**".
- The long button time described in this article is approximately 3 seconds.
- LCD display two lines of characters.

After inverter initializing, main interfaces will be displayed circularly:

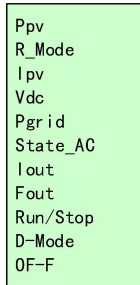

Ppv  
R\_Mode  
Ipv  
Vdc  
Pgrid  
State\_AC  
Iout  
Fout  
Run/Stop  
D-Mode  
OF-F

Figure8-6 Main interface

Main interface display basic running information. Main interface will turn page auto after 10s, or you can turn page through pressing "UP" and "DOWN" button.



Noted!

JNPxL series inverter with single-phase water pump load is powered on for the first time, the motor parameters will be detected. After passing the detection, the next operation will be carried out according to the LCD operation prompt.

## 8.3 System parameter query and setting

### 8.3.1 Query information item description

The query information items include main interface information, operation information, basic information, water pump information, statistical information, and fault information.

All query information items can be queried on the LCD display interface.

"Figure 8-2 LCD menu block diagram 1" lists the locations where all queried information items are located.

The following describes the operation information, basic information, pump

information, statistical information, and fault information.

### 8.3.1.1 operation information

The items in the operation information show the current operation information of the inverter. The following table explains each item in detail.

Figure8-3 The meaning of main interface parameters

<b>RunInfo</b>	<b>Introduction</b>
Vdc	Inverter input voltage (V).
Ipv	Inverter input current (A).
Ppv	Inverter input power (W).
Vgrid	Inverter current Grid input voltage (V)
Pgrid	Inverter current Grid input power (W)
State_AC	Inverter current Grid input situation
Fout	Inverter output current frequency (Hz).
Iu	Inverter output U phase current (A).
Iv	Inverter output V phase current (A).
Iw	Inverter output W phase current (A).
Temp	Inverter radiator's temperature(°C).
ErrCode	Inverter current fault mode.
StopCode	Stop code, can check the reason of inverter shut down most recently.
S-Mode	Start and stop mode.
D-Mode	Protection mode against well dry out.
OF-F	Water overflow alarm function optional in Solar pump system storage device.
Run/Stop	run /stop status.
GPRS	The connecting situation of inverter's GPRS.
ESC	Return to the previous menu.

### 8.3.1.2 Basic Information

InverterInfo, shows basic information of inverter, please refer to the figure below.

Figure 8-4 Basic Information Details

Inverter Info	Explain
LCD-Ver	Version information of LCD program.
DSP-Ver	Version information of DSP program.
SiteNum	Site number of network node of inverter, when communicate with RS485. Default value is 10. If modifiable, please refer to “8.3.4.4Site Number Set”.
SN	Series number of inverter.
Ty	Type of inverter.
ESC	Return to the previous menu

### 8.3.1.3 Pump Information

Pump information item show the basic information of pump.

Figure 8-5 Pump information description

Pump Info	Description	Remark
Hpump	Pump running lift head (m)	The rated head, rated flow and rated speed in the setting menu must be set first; otherwise, they all appear to be zero.
Qpump	Pump current water flow (m <sup>3</sup> /h)	
npump	Pump current running speed (r/m)	
Pout	Pump current power (W)	

Vday	Pump daily water output on that day (m3)	
Vtol	Pump total water output (m3)	
ESC	Return to the previous menu	

### 8.3.1.4 Statistic Information

Statistic Information, statistic of the totally running time and power generation of inverter. Please refer to figure below

Table 8-6 Detailed statistic data

Statistic	Description
RunT-D	Inverter daily running duration. This figure will be reset when recharged.
RunT-T	Accumulative running duration..
E-Day	Daily power inverted. This figure will be reset when recharged.
E-Tot	Accumulative power inverted
ESC	Return to the previous menu

### 8.3.1.5 Fault Inquiry

Fault Inquiry, to inquiry current and historic malfunction.

Table8-7 Fault inquiry

Fault Inquiry	Explain
Current Fault	Current fault inquiry
History Fault	History fault inquiry
ESC	Return to the previous menu.

### 8.3.2 Setting information Item Description

Setting information items are all under the parameter setting menu, including setting of scheduled down time, DSP parameter setting, water pump information, site number setting, zero clearing point information, zero clearing fault information, password setting and language setting.

"Figure 8-2 LCD Menu Block Diagram 1" and "Figure 8-3 LCD menu block Diagram 2" list the parameter Settings and the locations of all settable information items under this menu. The following will give a detailed introduction to each setting item.

### 8.3.2.1 Setting of regular stop time

This setting item is used to set the fixed stop time of the inverter, which is convenient for users to set according to their needs and make the inverter stop itself within the set time.

Table 8-9 Description of regular downtime setting

Timed shutdown information	Description	Note
Time	The inverter will stop automatically in minutes after reaching this time ( Minutes).	

### 8.3.2.2 DSP parameter setting

Used for setting key parameters of solar pump inverter system.

Table 8-10 DESCRIPTION of DSP parameter setting



DSP Parameter Setting Information	Description
Imotor	Motor overload current protection value, refer to the water pump motor nameplate to set this parameter, it is recommended to be the same as 1.2 times the motor rated current value.
Im-Rate	Motor rated current (this parameter is only valid for single-phase pump motor parameter detection, and the setting value is recommended to be 60% of nominal rated current of load pump).
D-power	Dry protection power, which shall be reset when the load power rating is lower than Solar pumping inverter. Recommended value is 40% of the rated output power of Inverter. For example, the D-Power of 2.2kW pump is 880w.
D-time	Dry out recovery time, under auto dry out mode, after the warning of dry out and inverter shut down, the duration from shut down to restart. Default value is 30. Default duration is 30 minutes.
StopFreq	Stop frequency (Hz). Setting principle is stop frequency when minimum flow is output.
F-Limit	Frequency limit, the maximum frequency that the inverter can output. the default value is "50Hz"or"60Hz"
Load	For selection of load. This figure differs by different pump. When the load is set to UX/50Hz or UX/60Hz, use it in conjunction with the "Rated Voltage" in the DSP parameter Settings.

D-mode	For choose the dry out protection mode. When water sensor is applied, dry protection mode should be set to detect dry protection. Default is "DETECT".
OF-F	For choose over flow warning function. Default is no overflow warning. If you want to use this function, please set to "on". Default is "OFF".
OF-Time	For choose over flow warning function. Over flow recovery time, after the warning of over flow and inverter shut down, the duration from shut down to restart. Default value is 30. Default duration is 30 minutes.
M-Mode	If water output is abnormal, and caused by reversed motor phase sequence, you can try to reset this model from "REV" to "FWD". Default is "FWD".
DebugMod	This value represents the operation mode of the inverter: "economy" : the inverter is in economical mode, automatic selection system based on photovoltaic energy grid energy intervention; "Reliable" : the inverter is in a reliable mode, the system detects the grid input and uses the grid energy to ensure the maximum frequency operation of the inverter; "Group control" : the inverter is in the group control mode, and the inverter runs as a slave; "3" : The inverter is in the motor parameter detection mode (this mode is set by default when the single-phase pump inverter is delivered from the factory. After the motor parameter detection is completed, the debugging mode will automatically switch to 0. If other modes need to be switched, manual switch will be

	needed again).
Facc	When the economic mode is selected, when the operating frequency is lower than the access frequency, the power grid is connected to ensure the maximum power operation of the inverter. (This parameter setting value must be greater than stop frequency)
Pexit	When the economic mode is selected, the photovoltaic power is higher than the exit power, and the grid exit ensures that the inverter only uses photovoltaic energy. (This parameter setting is recommended to be about 75% of the load pump power, and the minimum power change is 100W.)
SUKP	The debugging mode is effective under "group control", and the slave KP is adjusted.
SUINST	The debugging mode is effective under "group control", and the command voltage of slave machine is adjusted.
S_Out	Set the inverter output load type, select "0", the inverter is a three-phase output; When "1" is selected, the inverter is single-phase output.
W-Mode	Effectively, if the output is selected as "1" (single-phase output), modifications should be made under the guidance of customer service.
U-comp	When the output is selected as "1" (single-phase output), it is effective. When the inverter is far away from the pump, the inverter increases the voltage compensation. This modification shall be carried out under the guidance of the customer service

U-Rated	Rated output voltage, adjustable range of 130V~240V. With the load set to UX/50Hz or UX/60Hz, UX is the rated voltage.
ESC	Return to the previous menu.



Note !

When the user selects solar pump inverter, the parameters in the menu of "DSP Parameter Setting" have been set by factory, and these parameters cannot be changed easily.

- When the output selection is changed, the inverter must be powered off. It can only be started up again after the inverter is completely powered off. Otherwise, the inverter and water pump may be damaged.
- When the output of the inverter switches from three-phase to single-phase, it runs for the first time. The debugging mode must be changed from "Reliable" to "3" before starting up and running. If the output is switched from single-phase to three-phase, this step is not required.

### 8.3.2.3 Pump Information Setting

Used to set relevant parameters of water pump information.

Table 8-11 Description of water pump information setting (user sets according to water pump parameters)

<b>Pump Information Setting</b>	<b>Description</b>	<b>Note</b>
H_rate	Set pump rated lift head (m)	According to pump nameplate input Settings
Q_rate	Set pump rated water flow (m <sup>3</sup> /h)	
n_rate	Set pump rated speed ( r/m)	

#### 8.3.2.4 Site Number Set

SiteNum Set, for remote RS485 communication use. Please refer to the figure below.

Table 8-12 SiteNum Set Description

<b>Site Number Set</b>	<b>Description</b>	<b>Note</b>
SiteNum	Inverter network site number	The maximum value is 64.

#### 8.3.2.5 Statistical Data Clear

Clear S-Data, to clear inverter’s total running time and cumulative output power.

Table 8-12 Statistical Data Clear Description

Clear generation info.	Description	Note
Yes	Choose yes,clear the information of the inverter output power	
No	Return to the previous menu.	

**8.3.2.6. Historical Malfunction Clear**

Clear F-Data, to clear historical malfunction record.

Table 8-13 Historical malfunction clear information description

Historical Malfunction Clear	Description	Note
Yes	The option is to immediately clear the inverter historical Fault.	
No	Return to the previous menu.	

**8.3.2.7. Password Setting**

Password Setting, to set the password to enter set menu.

Table 8-14 Password setting description

Password set	Description	Note
<b>New Password</b>	Set the password to enter the Settings menu.	The default initial value for a two-digit password is 00, and the maximum value can be set to 99.

### 8.3.2.8. Language Setting

Language setting, to set the man-machine interface language category.

Table 8-15 Language set descri

Language set	Description	Note
Chinese	After confirming the setting, the LCD display language of the inverter is set to Chinese.	
English	After confirming the setting, the LCD display language of the inverter is set to English.	

### 8.3.2.9. factory data reset

Used to restore factory default configuration.

Table 8-17 Restore factory Settings setting instructions

Restore factory Settings information	Description	Note
factory data reset	After confirmation, select "Yes" or "No" to resume factory Settings	



### 8.3.3 Information inquiry

In the main interface, press the up and down keys to directly query the information displayed in the main interface, and press the "ENTER" key to ENTER the main menu, to query the detailed parameters of the inverter, and to set some parameters and functions.

The inquiry operation is shown here using the inquiry fault code as an example.

1) Firstly, located the "fault code" : According to the "Figure 8-2 LCD menu Block Diagram 1", the fault code is under the operation Information menu;

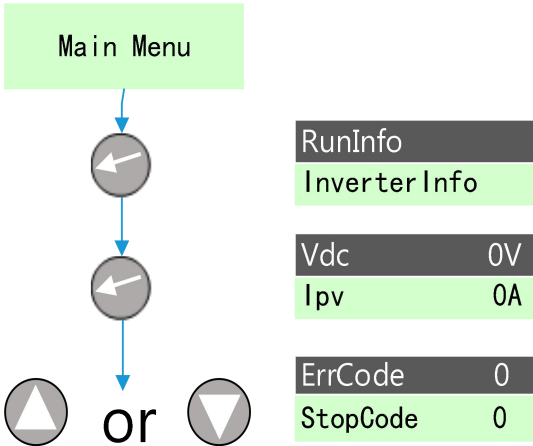
2) "Operation information" is the inquiry information item. The specific inquiry operation is as follows

Keys operation and LCD display	Description
 <p>Main Menu</p> <p>←</p> <p>RunInfo Inverter Info</p> <p>←</p> <p>Vdc 0V Ipv 0A</p> <p>←</p> <p>ErrCode 0 StopCode 0</p> <p>↑ or ↓</p>	<ol style="list-style-type: none"> <li>LCD is the main interface after startup;</li> <li>Press  to enter the main menu, and the cursor falls on the operation information item;</li> <li>Press  to enter the operation information item for query;</li> <li>Press the up or down key to</li> </ol>



	move the cursor and find the fault code.
--	--



#### Note!

All query information items can be inquired according to the above operation, and the fault information in the operation information is only illustrated here.

Please refer to "**8.3.1 Description of Inquiry Information Item**" for introduction of inquiry information item.

## 8.3.4 Parameter Setting



Enter the correct password before entering the parameter setting interface.

After entering the parameter setting menu, you can set the configurable information items given in "**8.3.2 Setting Information Item Description**".

Here, the setting operation is demonstrated only with the example of " D-power Setting ".

1) Position " D-power Setting " : According to the block Diagram of "Figure 8-2 LCD Menu", " D-power Setting " is in the "Parameter Setting" menu;

2) " D-power Setting " is the setting information item. The specific setting steps are as follows:

Keys operation and LCD display	Description
<p>The diagram illustrates the navigation process through the LCD menu. It begins with the 'Main Menu' screen. A right arrow key is pressed to move the cursor to the 'RunInfo' and 'Inverter Info' screen. From there, the up or down arrow keys are used to navigate to the 'Settings' and 'Fault Inquiry' screen. A left arrow key is then pressed to reach the 'Password *0' and 'ESC' screen.</p>	<ol style="list-style-type: none"> <li>1. Press  on the main interface to enter the main menu, and the cursor falls on the operation information item;</li> <li>2. Press the up key or down key to find the parameter setting item;</li> <li>3. Press  to enter parameter setting. Enter the correct two-digit password.</li> </ol> <p>* The initial default password is 00.</p>

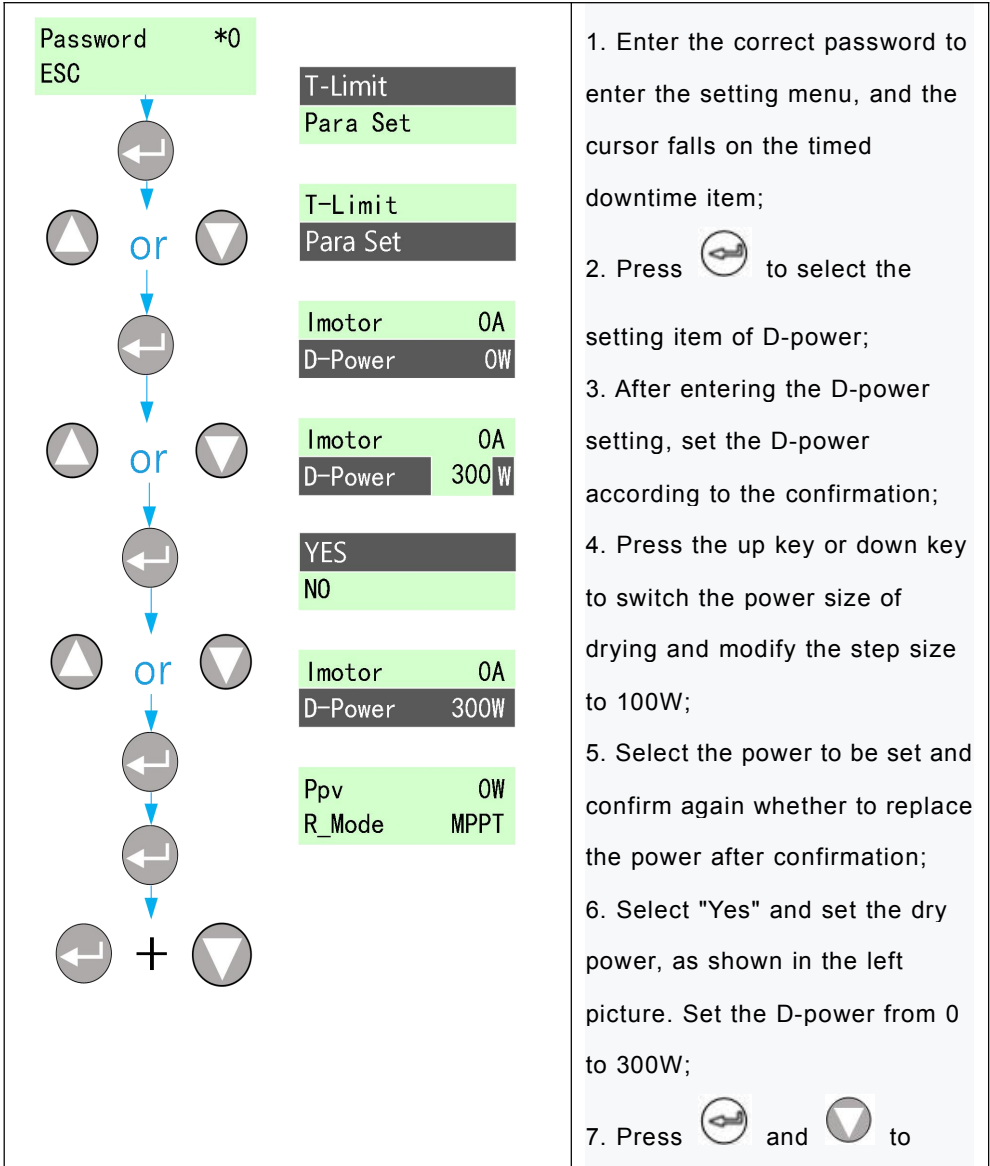

1. Enter the correct password to enter the setting menu, and the cursor falls on the timed downtime item;

2. Press to select the

setting item of D-power;

3. After entering the D-power setting, set the D-power according to the confirmation;

4. Press the up key or down key to switch the power size of drying and modify the step size to 100W;

5. Select the power to be set and confirm again whether to replace the power after confirmation;

6. Select "Yes" and set the dry power, as shown in the left picture. Set the D-power from 0 to 300W;

7. Press and to

return to the main menu.



Note!

All information items given in **"8.3.3 Setting Information Item Description"** can be set according to the above operation, which is explained here only by taking the setting of D-power as an example.

## 8.4 Malfunction Description

If communication failure appears, the below interface will appear.

Comm Error

This interface will appear, and Fault red led flickers to show malfunction, this means internal communication malfunction is appear.

Fault: 2  
Fault105

Display show malfunction, fault LED lights up, shows inverter malfunction or stop. Press "UP" or "DOWN" to inquire current malfunction, choose "ESC", press "ENTER" to quit. (When LCD screen show fault code, and fault LED lights up, which mean inverter fault or stop. Press "UP" or "DOWN" to inquire current fault, choose "ESC", press "ENTER" to quit.)



### Note !

Malfunction manual reset function: when the machine breakdown with malfunction, can long press "ON/OFF" button, the machine can automatically restart immediately. When the machine is displayed Fault112, no such reset function.

The following table shows the possible fault codes and status names of the inverter.

Table 8-16 Fault codes and status names

LCD displays fault code and status code	Name of malfunction and condition
Fault 100	Drive over current fault
State 101	PV Array under voltage
Fault 102	Bus over-voltage
Fault 103	Retention (bus equalizing fault)
Fault 104	Radiator over heating
Fault 105	Output over-load
Fault 106	Array over-voltage
Fault 107	Array over-current
Fault 108	Inverter AC Output over-current
State109	Dry alarm
State110	Weak sunshine
Fault 111	Temperature sensor fault
Fault 112	Short circuit fault (Nonrecoverable)

Fault 113	Initialization error from the machine
State 114	Overflow alarm
Fault 115	Output phase lose
Fault 202	Grid power over current
Fault 203	Bus voltage under voltage
Fault 204	Grid phase lose

# 9 Malfunction and Troubleshooting

## 9.1 Troubleshooting

Once malfunction or stop condition appears, the malfunction LED will lighten up, LCD will display current malfunction or stop condition, current malfunction will be recorded by the system for later inquire. Please refer to the form below which covers the fault and troubleshooting.

Table9-1 Shutdown status and troubleshooting

Condition code	Condition Name	Phenomena	Cause value	Troubleshooting
State 101	PV Array undervoltage	Inverter shutdown when the fault appeared and will automatically restart after it disappear.	Out put energy from array changes.	Please check the input voltage from array and make sure this voltage inside inverter input voltage range. Note: In cloudy days, morning, or down, this situation is not malfunction.
State 109	Dry alarm	Inverter shut down until the water level recover or protection recover time is up, the machine	Water level of source is lower than low-level water level sensor, even lower	1. Please check the water level, if the water level is ok, please check if there are air inside pump. 2. Please check the position of water

		will restart automatically.	than inlet of pump.	level sensor.
State 110	Weak sunshine	Inverter shutdown. When malfunction disappear, inverter can restart automatic.	Array output low.	Usually appears in early morning, dusk and cloudy days. This situation is aim to protect the motor of pump and lengthen the lifetime.
State 114	Overflow alarm	Inverter shut down until the water level recover or protection recover time is up, the machine will restart automatically.	Water level in container higher than high-end level sensor.	If this situation appears more than once, please check onsite and set the water level sensor at a proper height.

Table9-2 Malfunction and troubleshooting



Condition code	Condition Name	Phenomena	Cause value	Troubleshooting
Fault105	Output over-load	Inverter shutdown and will restart automatically after the fault disappears.	Load higher than rated output power of inverter.	<p>1. Please make sure the system is proper designed. The power of pump motor should not be larger than inverter output.</p> <p>2. Make sure that the pump is working in the well range of head and flow.</p> <p>3. Please refer to “8.3.2.3 DSP Parameter setting” and “8.3.4 Parameter setting”, increase the</p>

				value of Imotor.
Fault106	Array over-voltage	Inverter shutdown and will restart automatically after malfunction disappears.	DC input voltage higher than maximum input voltage of inverter.	Please check maximum output voltage of array and make sure this voltage is below inverter maximum input voltage.
Fault107	Array over-current	Inverter shutdown and will restart automatically after the fault disappears.	Input current of inverter higher than rated maximum value.	If this happen, please contact SUPPLIER.
Fault108	Inverter AC output over current	Inverter shutdown and will restart automatically after the fault disappears.	1. Power capacity of pump motor is higher than rated output. 2. Pump motor locked-rotor , or	1. Please inspect whether pump motor is normal. 2. Please inspect whether pipeline system is in

			damaged. 3. Pipe system design is not reasonable.	accordance with water pump or not. 3. If this happen frequently, please contact SUPPLIER.
Fault111	Temperature sensor fault	Inverter shut down.	Sensor not connects proper or damaged.	If this happen frequently, please contact SUPPLIER.
Fault112	Short circuit fault (Nonrecoverable )	Inverter down, can not recover the fault, unless the inverter is new power, otherwise the system will not start.	1.The inverter output appears interphase short circuit, to the ground fault, missing items and a short period of time multiple overcurrent fault;	1. Please check if there is short circuit in output wires. 2. Whether the pump motor is damaged.

			2. Inverter hardware circuit damage.	
Fault115	Output phase lose	Inverter shutdown and will restart automatically after the fault disappears.	Phase loss in inverter output.	<p>1. Please check if the output wires are proper connected and fixed.</p> <p>2. If this happen frequently, please contact the supplier.</p>
Fault 202	Grid power over current	Inverter stop working, stop state disappear, system will start automatically	<p>1,Pump is short circuit or blocked.</p> <p>2,hardware problem</p>	<p>1,check pump wiring, and chek if pump can working normally.</p> <p>2,Check if inverter output is norma.</p>

Fault 203	Bus voltage undervoltage	the inverter shut down, the system can start itself after the shutdown state disappears.	Grid power undervoltage , or PV array low voltage, or hardware fault.	Disconnect with AC input, PV input, ensure inverter no voltage, use multimeter to check the voltage of grid power and PV array separately.
Fault 204	Grid power phase lose	Inverter stop working, stop state disappear, system will start automatically	A phase or two-phase output cable of grid power is not well connected with inverter. The grid power connection is loose and falls off.	Disconnect the grid power and PV input switch to ensure that there is no voltage at the input of the inverter, and check the wiring at the input side of the grid

## 9.2 Maintenance

Please check and ensure the inverter is not charged with electricity before any maintenance.

**A routine examination must be done every half year:**

- Check the inverter for damaged or with deformation.
- Check whether there is abnormal noise when inverter is running.
- Check whether the parameters and time settings are correct.

**Every half to one year, a routine examination should be done:**



**Warning!**

Please check and make sure the inverter is not charged with electricity before any maintain work below.

- Check humidity and dust of inverter surrounding environment, if have too much dust, clean the inverter.
- Check the inverter cable connection is loose, if loose, tightening again according to the connection method of wire.
- Check whether the cable is damaged, especially the metal surface contact surface is cut marks or not.

### **9.3 Contact Customer Service**

In order to provide faster and better service, please provide us with information below:

- Model of Inverter
- Series number of inverter
- Malfunction name and time
- Malfunction description

# 10 Appendix A

## Technical Data

Model	JNP2K2L-V5	JNP3KL-V5	JNP3K7L-V5	JNP4KL-V5
<b>PV input parameter</b>				
Maximum DC input voltage	480Vdc			
Recommended MPPT voltage range	200~450Vdc			
Maximum DC input current	15A	30A	30A	30A
MPPT maximum efficiency	99%			
Number of input lines	1			
<b>Utility/diesel input parameters</b>				
VDC	198-264Vac, 1PH			
frequency	50Hz/60Hz(±3%)			
<b>AC output side</b>				
Maximum matching motor power	2.2kW	3kW(3PH) or 2.2kW(1PH)	3.7kW(3PH) or 2.2kW(1PH)	4kW(3PH) or 2.2kW(1PH)
Rated output voltage	220/230Vac (1PH or 3PH)			
Output	0~50/60Hz			

frequency range				
maximum current output	15A	16A	17A	18A
<b>system</b>				
IP Grade	IP65			
Operating ambient temperature range	-25~60℃			
type of cooling	natural cooling			
display	LCD/LED			
communication	RS485/GPRS			
altitude	3000m, downscaling operation above 3000m			
noise	<50dB			
meet a criterion	EN 50178; IEC/EN 62109-1;IEC61000			
Specification size (W/H/D)	278/370/125(mm)			
weight	6.5kg			



# 11 Appendix B

## 11.1 Quality Assurance

The product malfunction in the warranty period, Supplier be free to repair or replace products. The warranty period take the contract as a standard.

### **Evidence**

During the warranty period, customers should provide the invoices for the purchase of products and date. And the trademarks of the products should be clearly visible. Otherwise we do have the right not to assume quality assurance.

### **Conditions**

- The replaced products should be returned to supplier.
- Supplier should be given reasonable time to repair the malfunctioning equipment.

### **Exemption from liability**

The company has the right not to carry out quality assurance in the following:

- Transport damage
- Incorrect installation, modification and usage.
- Overall, components have been beyond the warranty period.
- Bad operating environment beyond the descriptions in this manual.
- Non company services, personnel to repair, replacement or demolition cause machine damage.
- Damage caused by abnormal natural environment.

If the product size and parameters have changed, the latest information given by the company shall prevail without notice.

## **11.2 Contact Us**

If you have any question about Solar Pump Inverter, please contact Supplier.